

# Department of Labor and Workforce Development

## Employment Security (ES) Division

### Unemployment Insurance (UI) Program

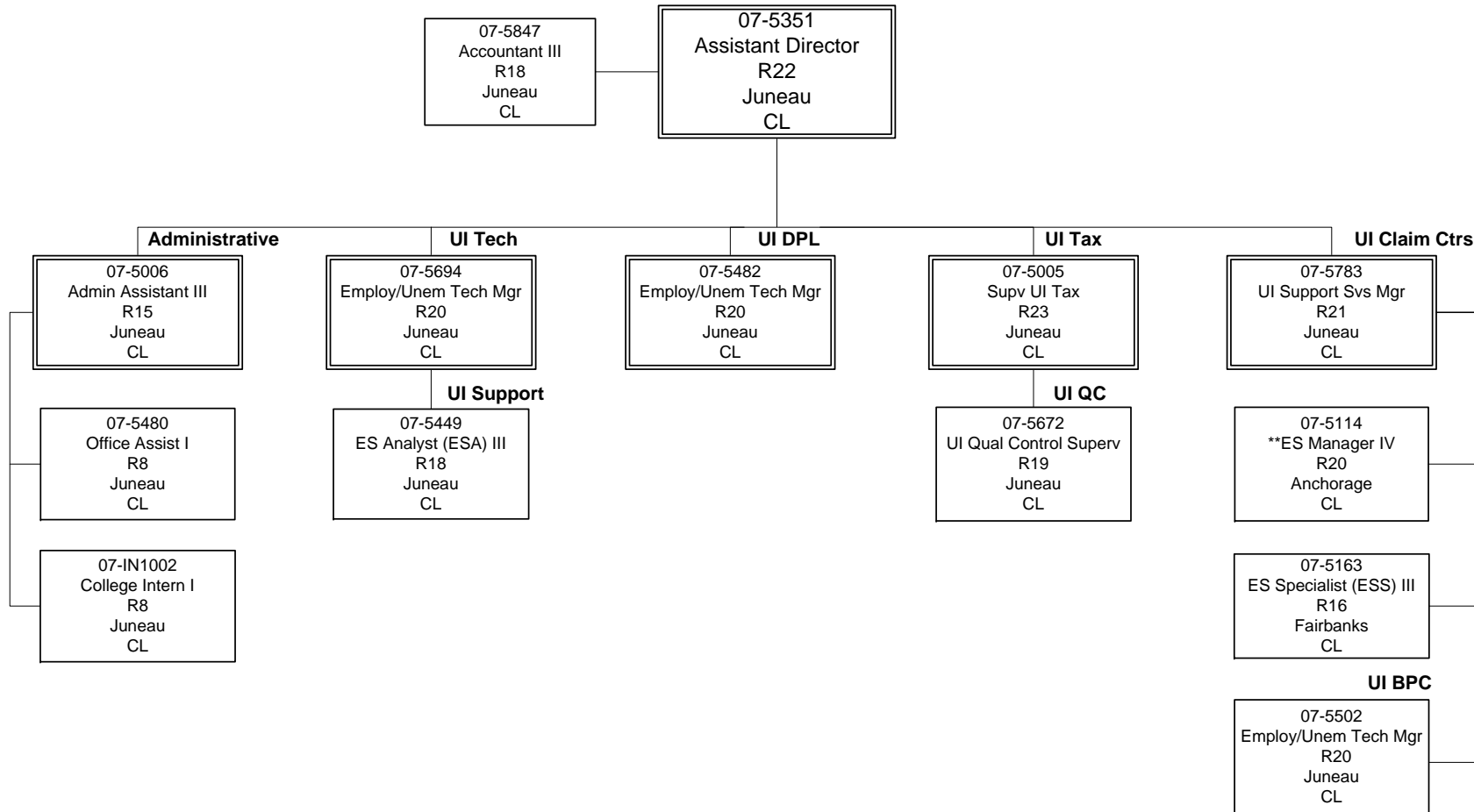

# Department of Labor and Workforce Development

## Employment Security Division

### Unemployment Insurance Program

#### Anchorage UI Claim Center

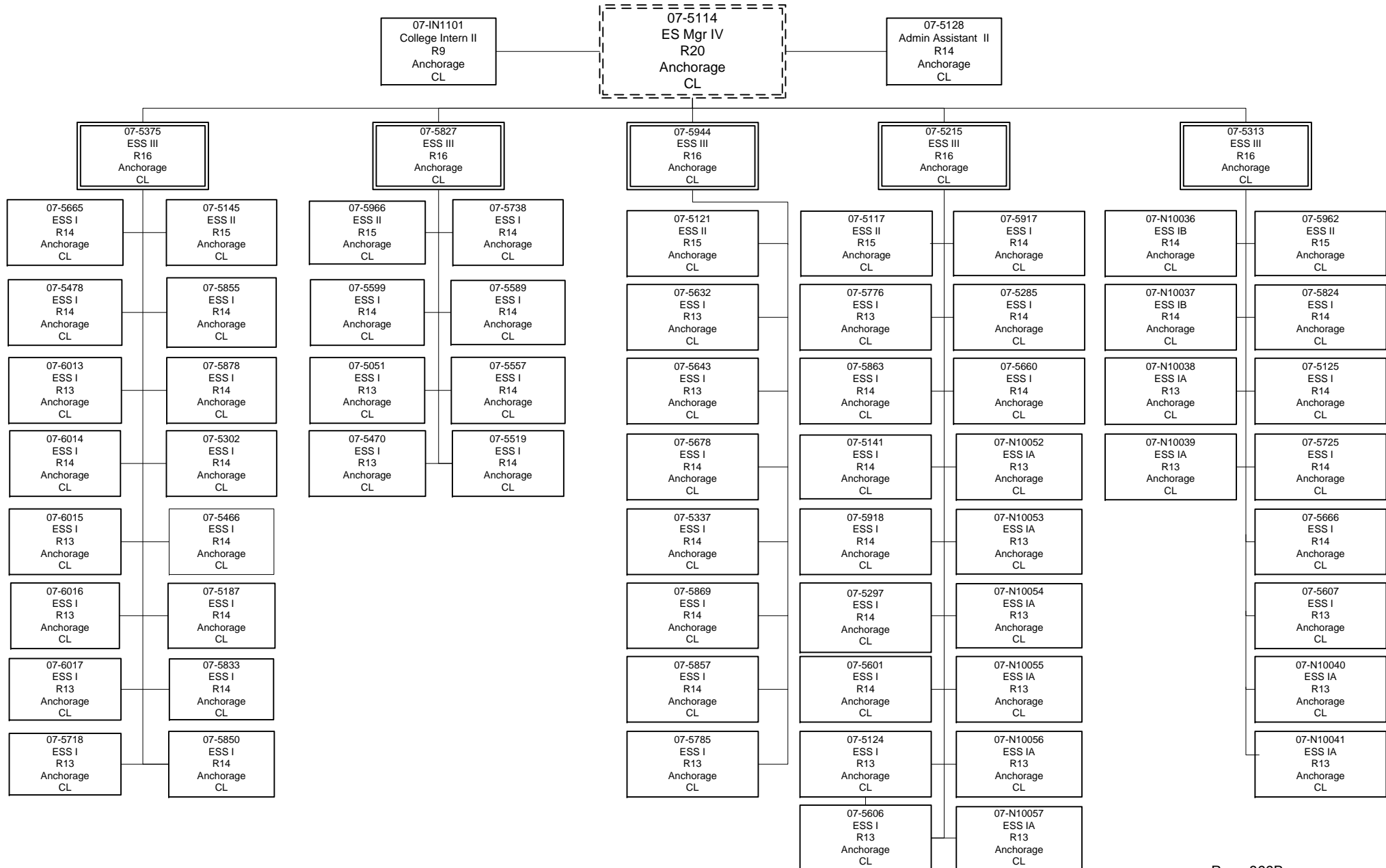

Department of Labor and Workforce Development  
Employment Security Division  
Unemployment Insurance Program  
Fairbanks UI Claim Center

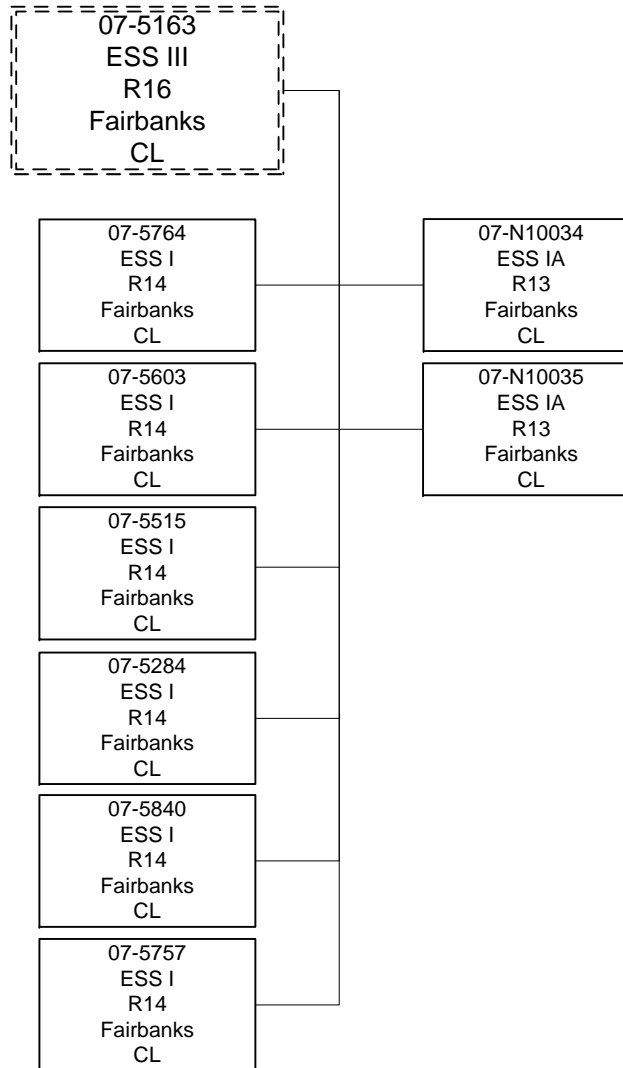

# Department of Labor and Workforce Development

## Employment Security Division

### Unemployment Insurance Program

#### Juneau UI Claim Center

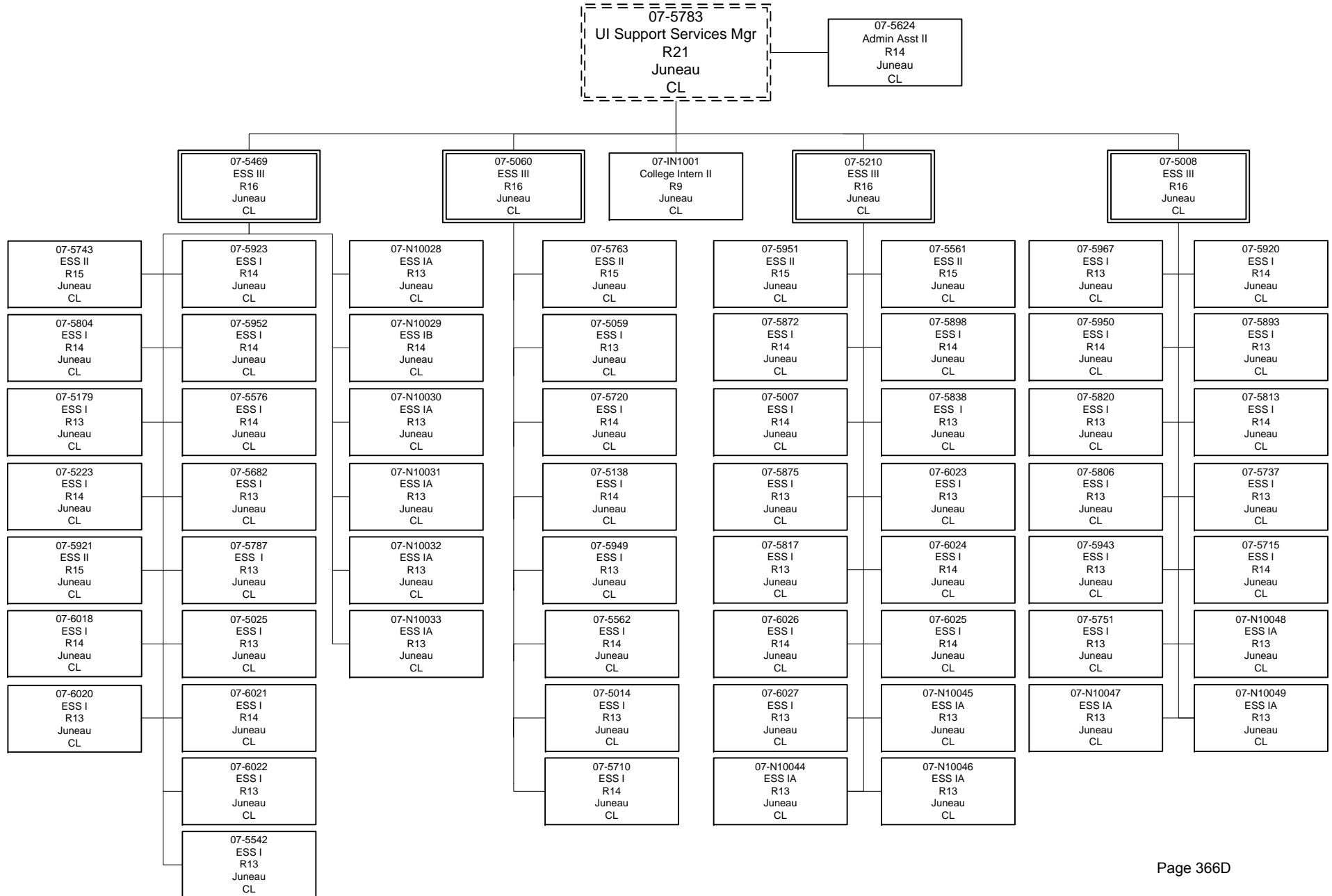

Department of Labor and Workforce Development  
Employment Security Division  
Unemployment Insurance Program  
UI Appeals Unit

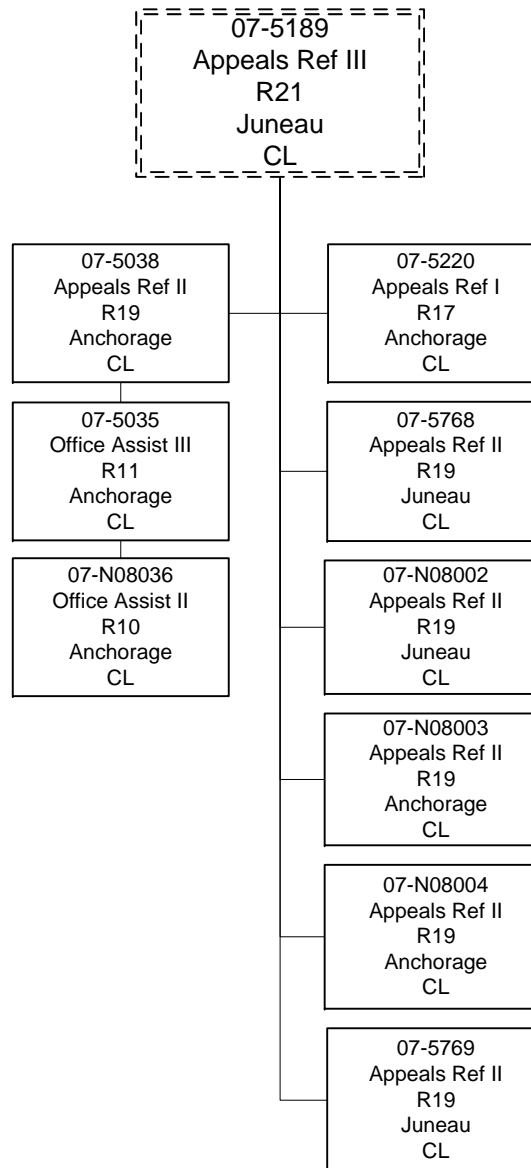

# Department of Labor and Workforce Development

## Employment Security Division

### Unemployment Insurance Program

#### UI Benefit Payment Control Unit

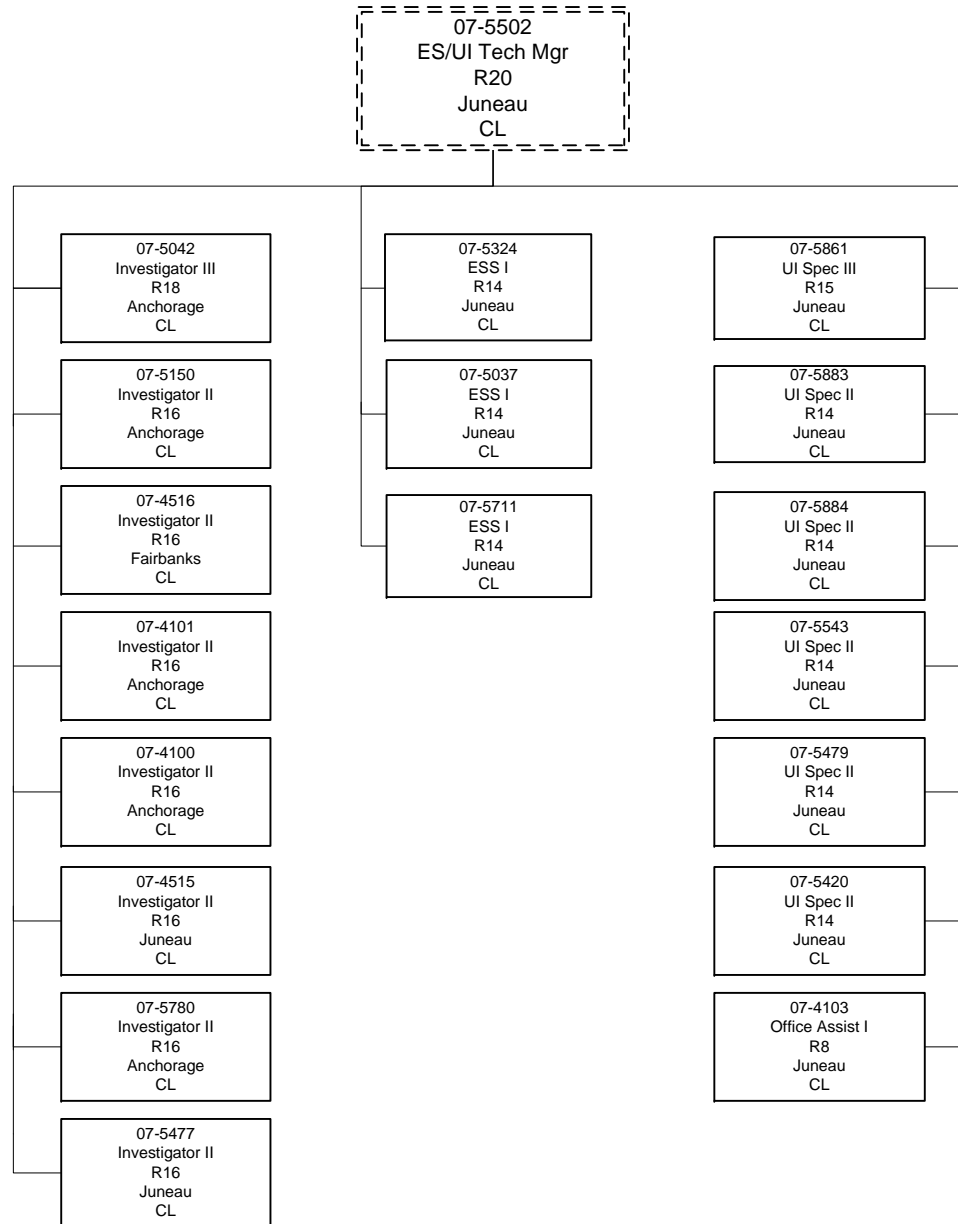

Department of Labor and Workforce Development  
Employment Security Division  
Unemployment Insurance Program  
DP Liaison Unit

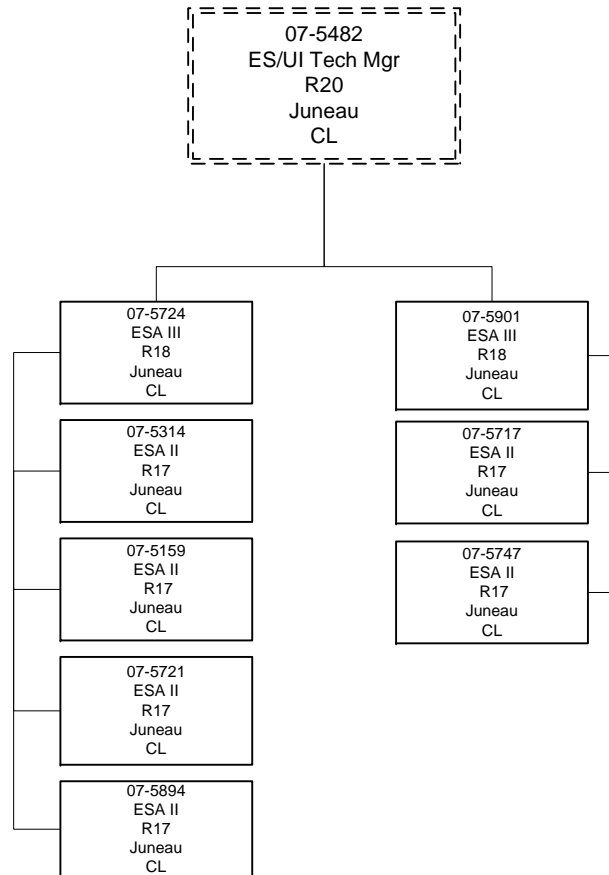

Department of Labor and Workforce Development  
Employment Security Division  
Unemployment Insurance Program  
UI Quality Control Unit

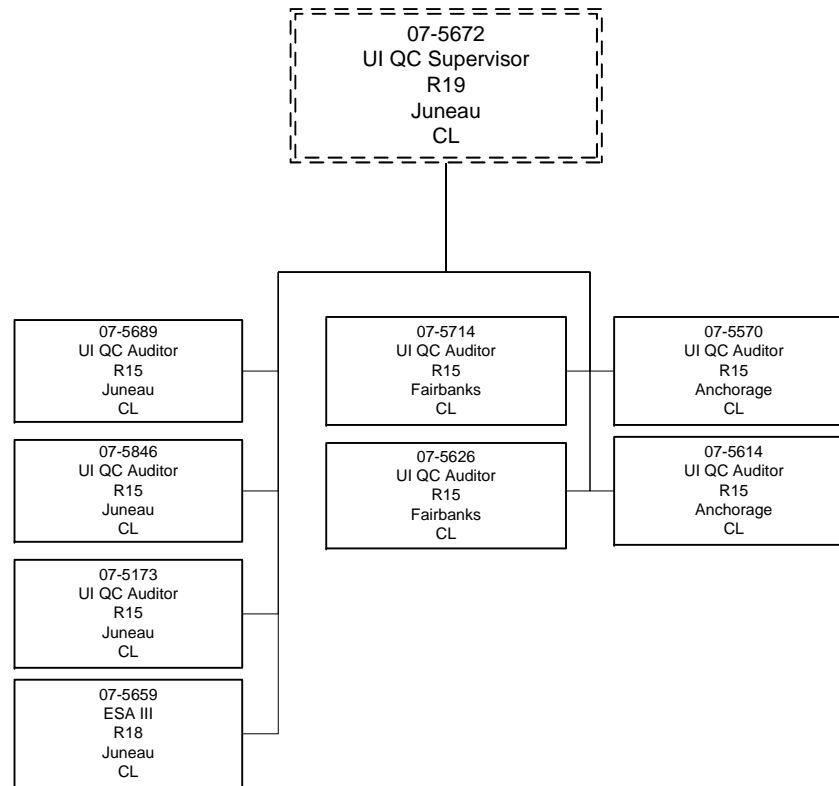



Department of Labor and Workforce Development  
Employment Security Division  
Unemployment Insurance Program  
UI Support Unit

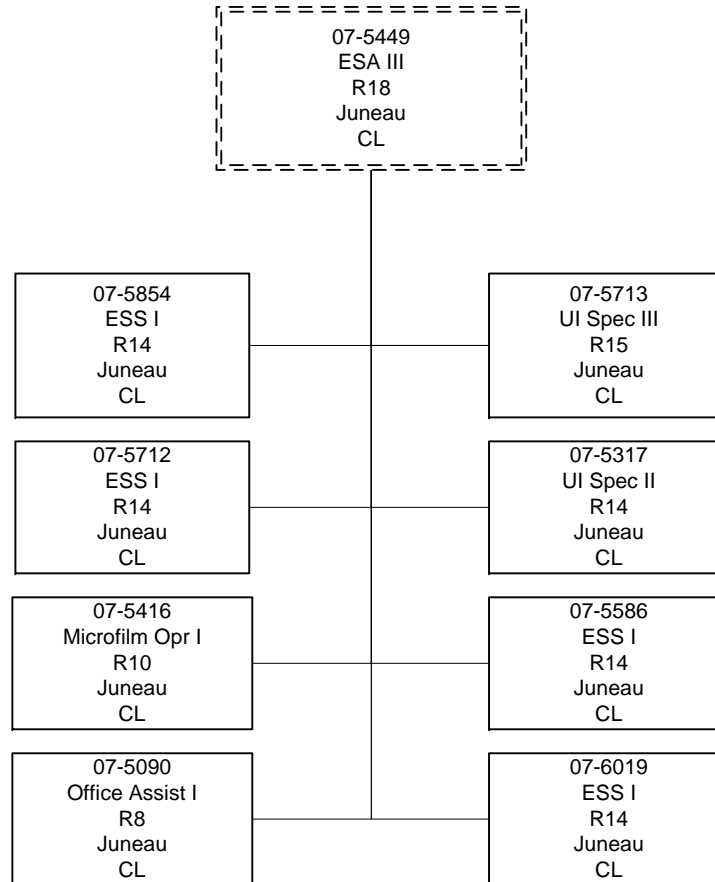

# Department of Labor and Workforce Development

## Employment Security Division

### Unemployment Insurance Program

#### UI Tax & Program Integrity

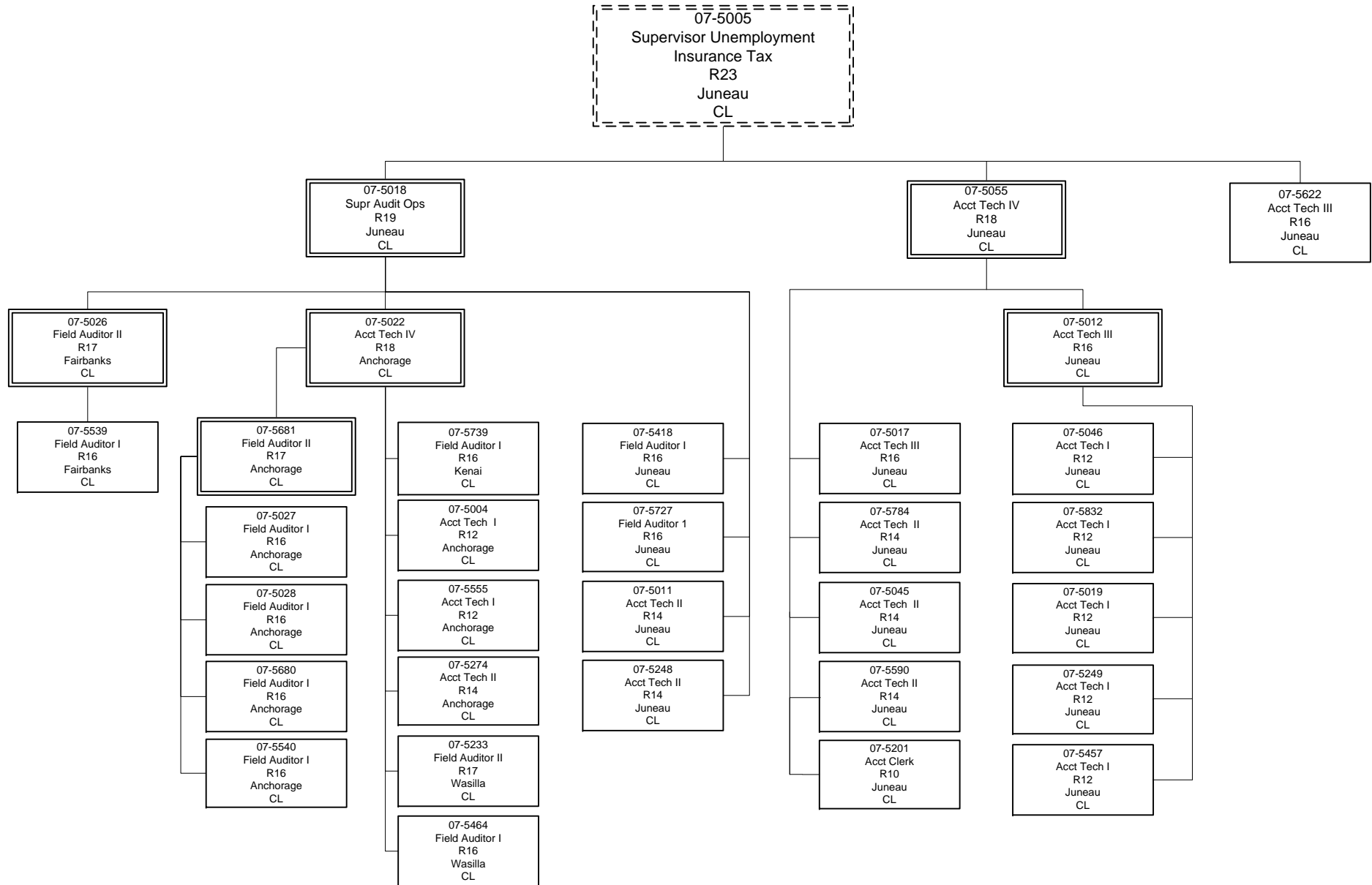

Department of Labor and Workforce Development  
Employment Security Division  
Unemployment Insurance Program  
UI Technical Unit

